

VITAL STATISTICS

Technical details, floor plans
and capacity charts - Metric

THE TECHNICAL STUFF



VENUE OVERVIEW

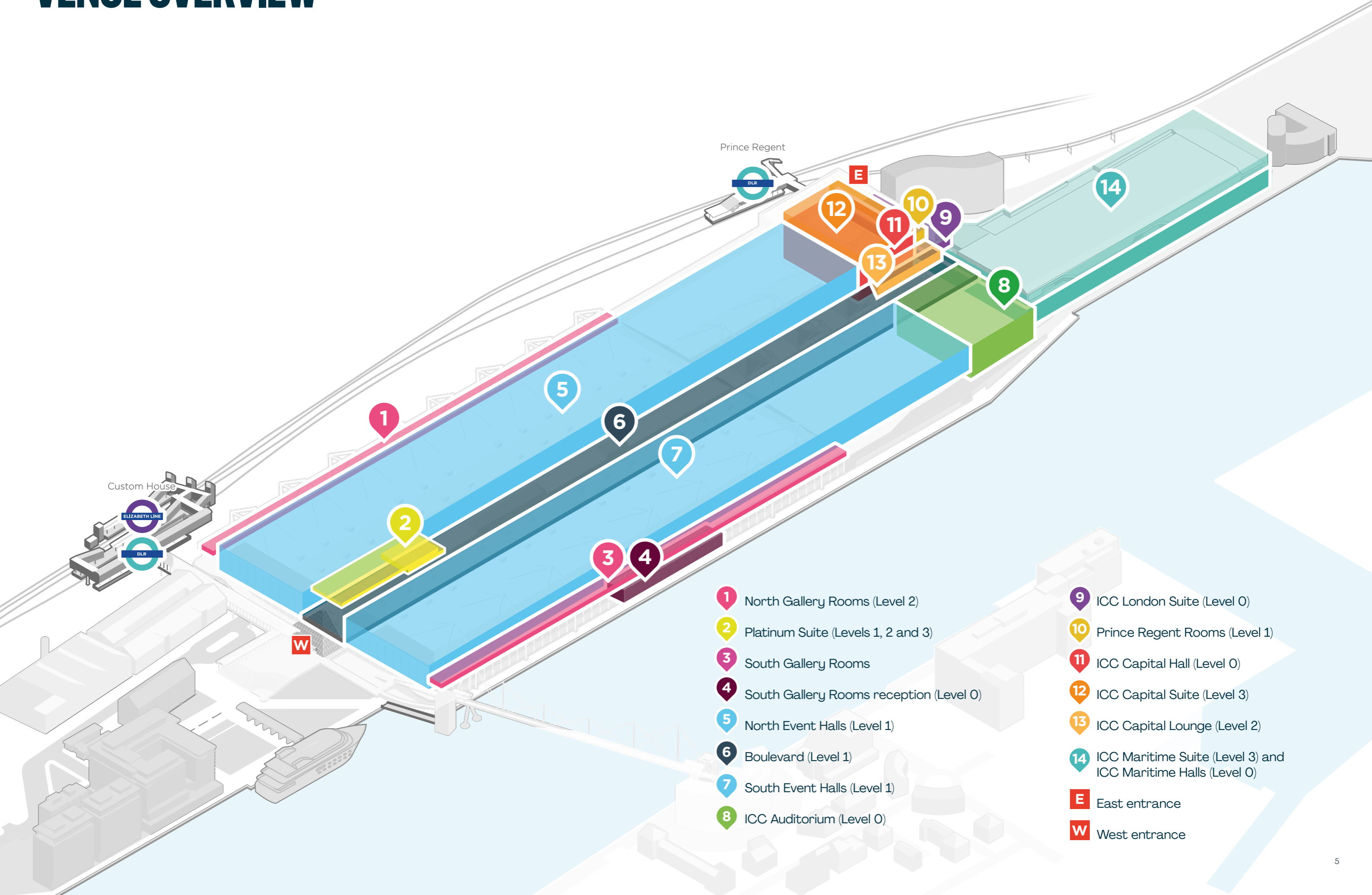

- 1 North Gallery Rooms (Level 2)
- 2 Platinum Suite (Levels 1, 2 and 3)
- 3 South Gallery Rooms
- 4 South Gallery Rooms reception (Level 0)
- 5 North Event Halls (Level 1)
- 6 Boulevard (Level 1)
- 7 South Event Halls (Level 1)
- 8 ICC Auditorium (Level 0)
- 9 ICC London Suite (Level 0)
- 10 Prince Regent Rooms (Level 1)
- 11 ICC Capital Hall (Level 0)
- 12 ICC Capital Suite (Level 3)
- 13 ICC Capital Lounge (Level 2)
- 14 ICC Maritime Suite (Level 3) and ICC Maritime Halls (Level 0)
- E East entrance
- W West entrance

EVENT HALLS

LEVEL 1

Key features

- Total capacity: 68,750 guests
- 84,328m² column free space (divided into North & South event halls)
- 2,000m² hall modules (N2-N22 & S2-S22): 86.4m (l) x 23.4m (w) x 10m (h)
 - N1 & S1: 1,000m² x 10m (h)
 - N23 & S23: 664m² x 10m (h)
- ICC Maritime Hall modules
 - Hall 1: 1,672m² x 9.6m (h)
 - Hall 2: 1,693m² x 9.6m (h)
 - Hall 3: 2,044m² x 9.6m (h)
 - Hall 4: 2,188m² x 9.6m (h)
 - Hall 5: 2,054m² x 9.6m (h)
 - Hall 6: 1,940m² x 9.6m (h)
- Easy visitor access from 12,000m² (600m long) central boulevard (Level 1)
- Moveable air walls
- Private lorryway accessing event halls with 7.5m (w) by 5.0m (h) drive-in doorways
- Event Hall floor weight loading: 18 kN/m²
- Permanent cabling including IT, electric, water, waste, compressed air - serviced by underfloor ducts every 5.0m North to South and 3.0m East to West
- Individually adjustable LED ceiling lights

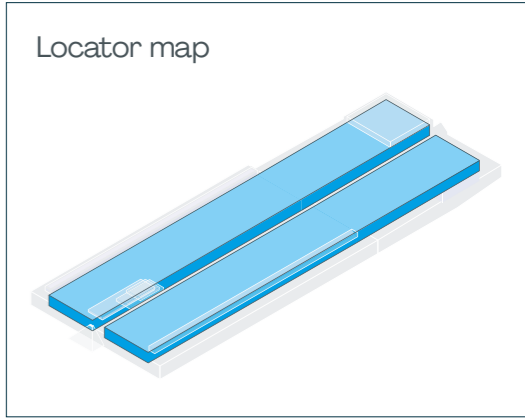

PLATINUM SUITE

LEVELS 1, 2 & 3

Platinum Suite - capacity chart

Platinum room (Level 3) configuration options

	Area	Dimensions	Height	Theatre	*Classroom	*Cabaret	*Banquet	Reception	Boardroom
Room 1 or 2 or 3 or 4	392m ²	14m x 28m	4.6m	360	200	192	240	360	n/a
Rooms 1+2 or 3+4	784m ²	28m x 28m	4.6m	680	400	384	480	720	n/a
Rooms 1-4	1568m ²	28m x 56m	4.6m	1,125	840	800	800	1,125	n/a
Titanium room	39m ²	3.7m x 10.6m	4.6m	n/a	n/a	20	n/a	15	20
Zinc room	22m ²	3.8m x 5.9m	4.6m	n/a	n/a	10	n/a	n/a	10
Organiser office	11m ²	3m x 3.9	4.6m	n/a	n/a	8	n/a	n/a	6

Platinum lounge and rooms 5, 6 and 7 (Level 2) configuration options

	Area	Dimensions	Height	Theatre	*Classroom	*Cabaret	*Banquet	Reception	Boardroom
Full use of lounge and rooms	650m ²		3.2m	260	n/a	n/a	n/a	600	n/a
Room 5	52m ²	5.6m x 9.4m	3.2m	70	24	32	40	70	20
Room 6	68m ²	7.2m x 9.4m	3.2m	90	30	32	50	90	20
Room 7	52m ²	5.6m x 9.4m	3.2m	70	24	32	40	70	20
Full use of rooms 5, 6 and 7 only	172m ²	18.4m x 9.4m	3.2m	260	100	104	130	260	40
Rooms 5, 6, 7 and breakout reception	290m ²	18.4m x 15.7m	3.2m	n/a	n/a	160	200	300	40
Rooms 5+6	120m ²	12.8m x 9.4m	3.2m	180	80	80	100	180	30
Rooms 6+7	120m ²	12.8m x 9.4m	3.2m	180	80	80	100	180	30

All capacities subject to floorplan approval.

*Classroom numbers are based on three per table (using 6 ft trestle tables); *Cabaret numbers based on a max of eight per table (using 5 ft round tables); *Banquet numbers based on a max of ten per table (using 5 ft round tables).

Platinum rooms 1 to 4

Facilities

- Dimmable house lighting
- All rooms fully blacked out (except for fire lights and vision panels in doors)
- 57Db noise resistant partition wall
- Feature wall lighting
- Central PA system for announcements

Door dimensions

- 1.5m (w) x 2.6m (h)

Freight lift dimensions & weight loading

- Lift size: 3.18m (w) x 5.9m (d) x 3.0m (h)
- Door size: 3.18m (w) x 3.0m (h)
- Weight loading: 5,150kg

Goods lift dimensions & weight loading

- Lift size: 1.75m (w) x 2.7m (d) x 2.39m (h)
- Door size: 1.3m (w) x 2.1m (h)
- Weight loading: 2,500kg

Maximum occupancy (entire suite)

- 1,125 people

Maximum loading

- Floor: 5.0kN/m²
- Roof: 0.8kN/m²
- Lighting bar loading is 150kg per singular bar with a load of 25kg per linear metre
- Six additional rigging points per quarter which are 250kg per point load

Platinum Suite Lobby

- 7.9m x 31.1m
- Total - 246m²

Additional power available on request

- 63 AMP 3 phase
- 125 AMP 3 phase
- 32 AMP 3 phase

Platinum rooms 5 to 7

Facilities

- Dimmable house lighting
- 57dB noise resistant partition wall
- Central PA system for announcements

Door dimensions

- 1.4m (w) x 2.0m (h)

Maximum loading

- Floor: 5.0kN/m²
- Roof: 0.6kN/m²

Equipment available on request

- Projector screen
- Ceiling projection mounting point

Platinum boardroom

Dimensions

- 7.5m (w) x 4.8m (l) x 2.5m (h)
- Total - 36.5m²
- Boardroom layout for 16 people

Facilities

- Dimmable house lighting
- In room temperature control
- Sound proof walls
- Storage cupboards

Door dimensions

- 0.84m (w) x 2.4m (h)

Maximum loading

- Floor: 5.0kN/m²

Equipment available on request

- LED screen with remote connectivity
- Logitech Meetup VC system
- Kramer Go2 Wireless Connection

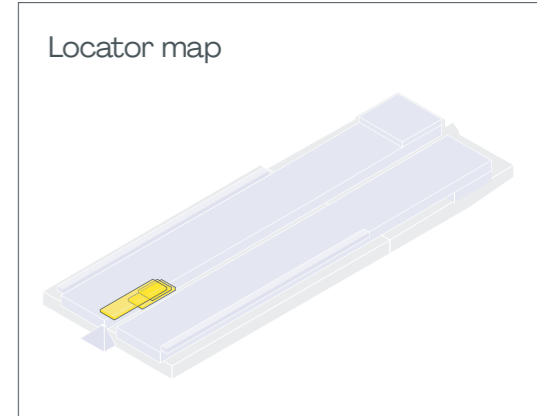

Platinum Suite – Level 3

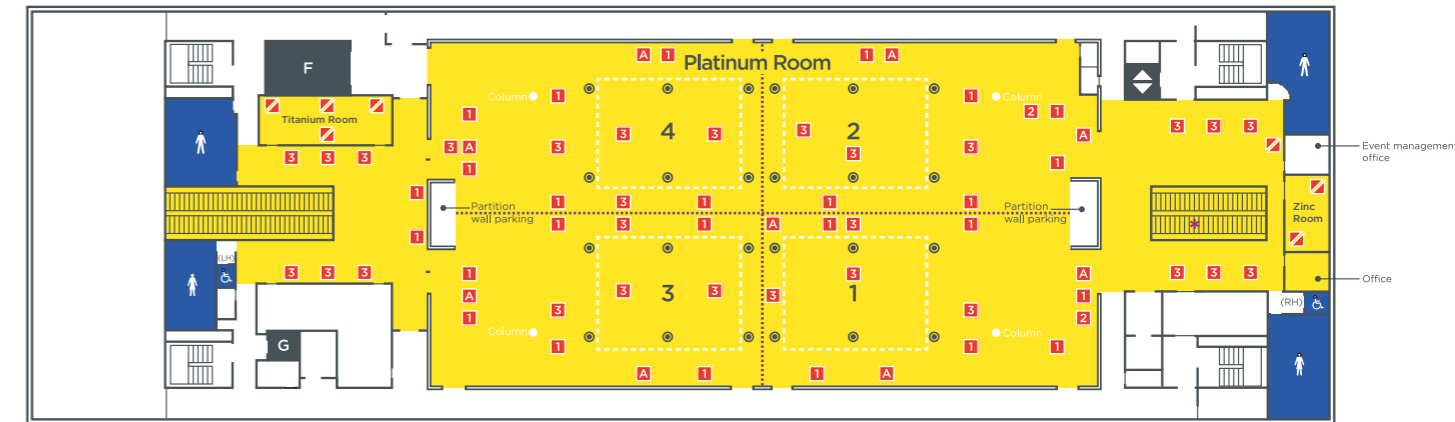

Key

- 1** Floor box type 1
2x 13 AMP sockets
4x jack plugs
- 2** Floor box type 2
2x 13 AMP sockets
1x 15 PIN female PC socket
1x video jack
2x 15 pair audio sockets (L & R)
1x 13 AMP projector plug
- 3** Floor box type 3
2x 13 AMP sockets
4x jack plugs + 2 spares
- A** 3 phase power supply available on request
- ▣** Pair fused and switched
13 AMP sockets
- Toilets**
♂ Male
♀ Female
♿ Accessible
(RH/LH – Right/Left hand)
- Lifts**
⬆️ Public
G Goods
F Freight
- ⋯ Partition wall
- ⊙ Rigging points (250kg loads)
- ⋯ Light bar/hanging point
- Demountable cloakroom counters

Platinum Suite Lounge and Meeting Rooms – Level 2

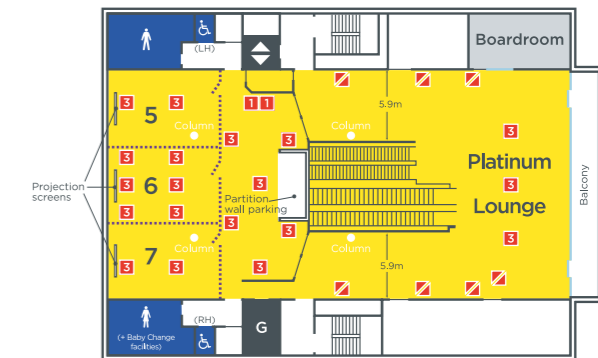

Platinum Suite Lobby – Level 1 (Boulevard)

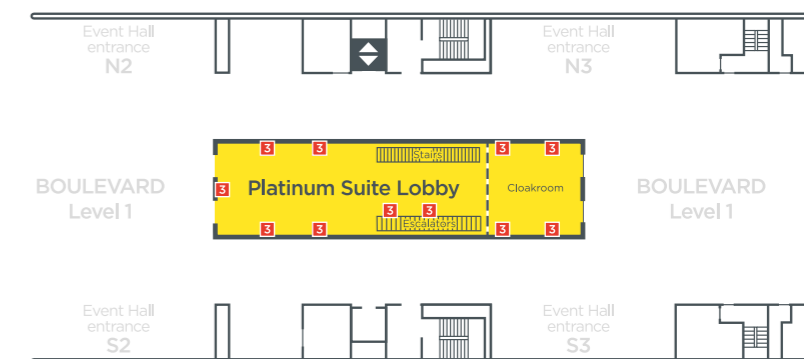

SOUTH GALLERY ROOMS

LEVEL 0 & 2

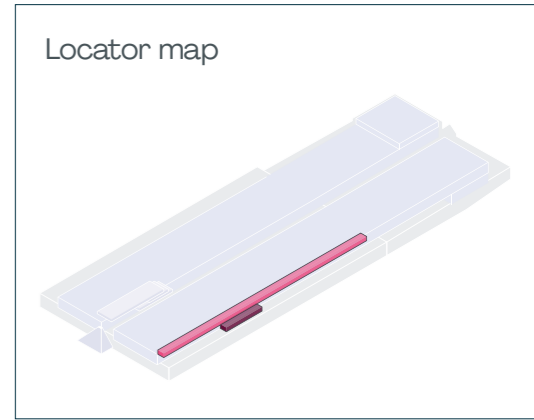

Meeting & training rooms

Levels 0 & 2

South Gallery Rooms - Level 2

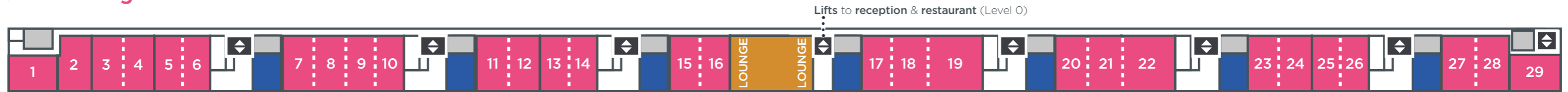

Large single room: 3, 4, 5, 7, 8, 9, 11, 12, 13, 15, 16, 17, 18, 20, 21, 23, 24, 25, 27, 28, 29

Small single room: 6, 10, 14, 26

Large double room: 3+4, 7+8, 8+9, 11+12, 15+16, 17+18, 20+21, 23+24, 27+28

Small double room: 5+6, 9+10, 13+14, 19, 22, 25+26

South Gallery Rooms - Level 0

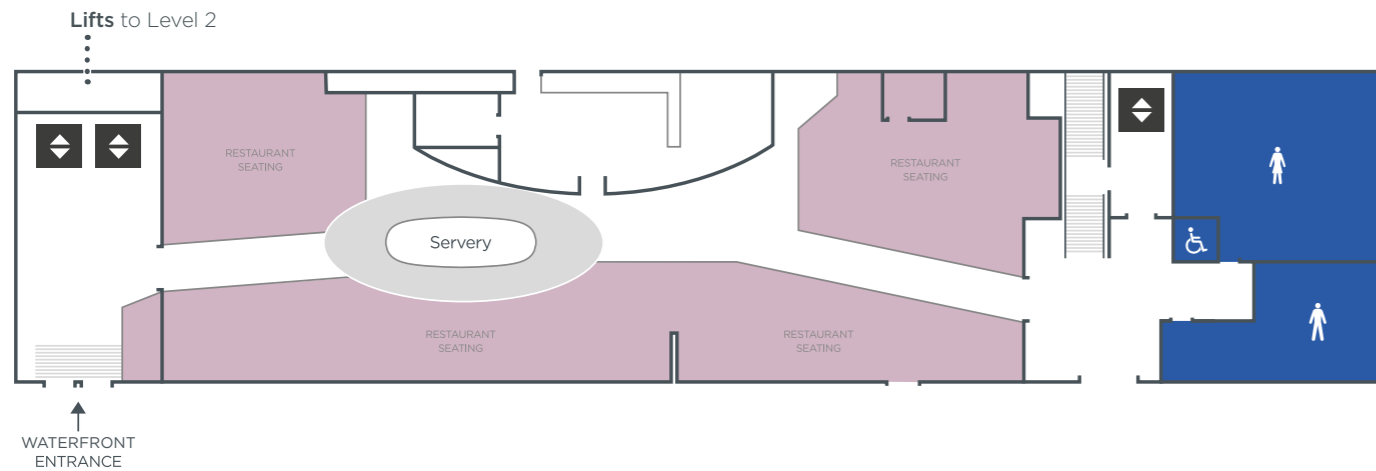

South Gallery Rooms plan - Rooms 1 to 6

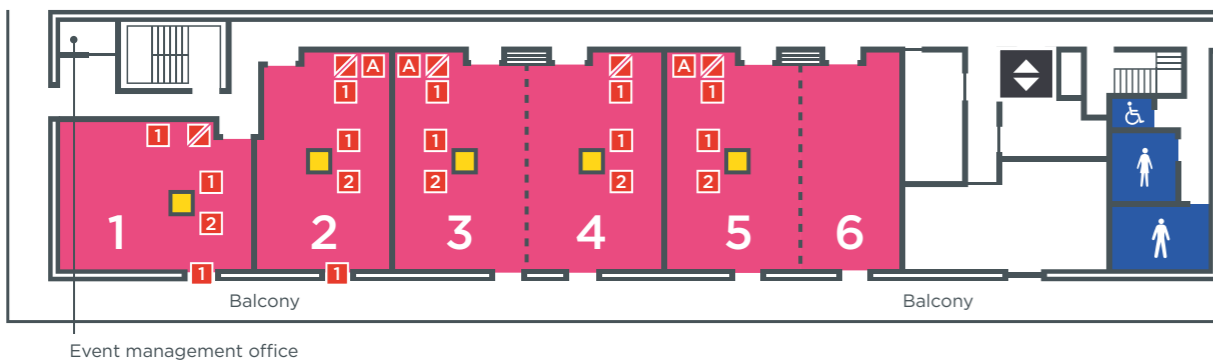

South Gallery Rooms - capacity chart

	Area	Dimensions	Height	Theatre	*Classroom	*Cabaret	*Banquet	Reception	Boardroom	U shape	*Exam
Large Single Room	93m ²	12.7m x 7.6m	3.25m	90	40	48	60	90	34	23	28
Small Single Room	66m ²	12.7m x 5.6m	3.25m	70	28	32	40	60	34	23	20
Large Double Room	194m ²	12.7m x 15.2m	3.25m	200	98	96	120	200	50	47	56
Small Double Room	168m ²	12.7m x 13.2m	3.25m	180	80	80	100	180	44	41	42
South Gallery Room 1	96m ²	8.7m x 11.1m	3.25m	90	40	48	60	90	34	23	n/a
South Gallery Room 2	95m ²	7.5m x 12.7m	3.25m	80	40	40	50	80	34	23	n/a
South Gallery Room 29	96m ²	8.7m x 11.1m	3.25m	90	40	48	60	90	34	23	n/a
South Gallery Rooms 8-10, 18+19 or 21+22	291m ²	12.7m x 22.8m	3.25m	304	118	144	180	304	60	65	n/a
South Gallery Rooms 7-10, 17-19 or 20-22	362m ²	12.7m x 28.4m	3.25m	400	145	*184	230	400	70	83	119

All capacities subject to floorplan approval.

*Classroom numbers are based on three per table (using 6 ft trestle tables); *Cabaret numbers based on a max of eight per table (using 5 ft round tables);

*Banquet numbers based on a max of ten per table (using 5 ft round tables); *Exam numbers based on single exam desk.

Facilities

- Dimmable house lighting
- All suites are acoustically sealed
- All rooms have sun blinds
- Ceiling projection mounting point
- In room temperature control
- Wardrobes available in rooms 11-22
- Natural daylight

Restaurant

- 454m² Seated restaurant for 200 people

Level 2

- Lounge: 201 m²
- Lounge capacity: 90 people

Door dimensions

- 1.4m (w) x 2.0m (h)

Maximum occupancy

- Single rooms: 90 people
- Double rooms: 200 people

Maximum loading

- Breakout areas: 5.0kN/m²

Passenger lift dimensions & weight loading

- Lift size: 1.86m (w) x 1.55m (d) x 2.4m (h)
- Door size: 1.1m (w) x 2.09m (h)
- Weight loading: 1,350kg

Key

- Ceiling projector mount point available on request
- ▨ Partition wall
- Toilets**
- ♂ Male
- ♀ Female
- ♿ Accessible
- ◄ Public lifts
- Stairs to Event Halls only

NORTH GALLERY ROOMS

LEVEL 2

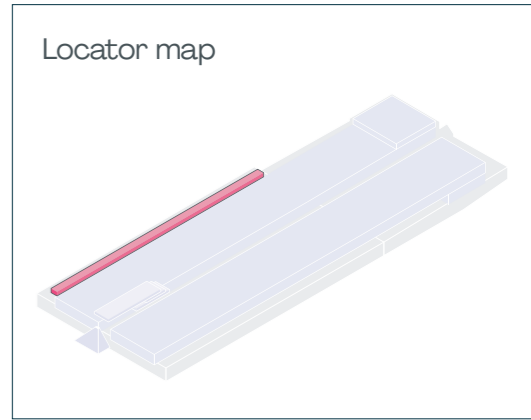

North Gallery Rooms

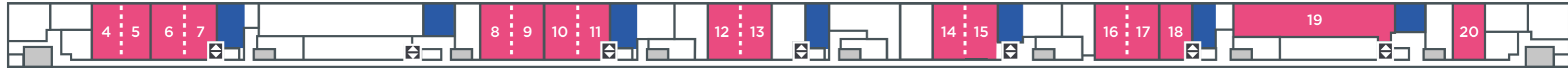

Please note: North Gallery Rooms 7, 11 and 18 are slightly indented due to the public lift

North Gallery Rooms plan - Rooms 4 to 7

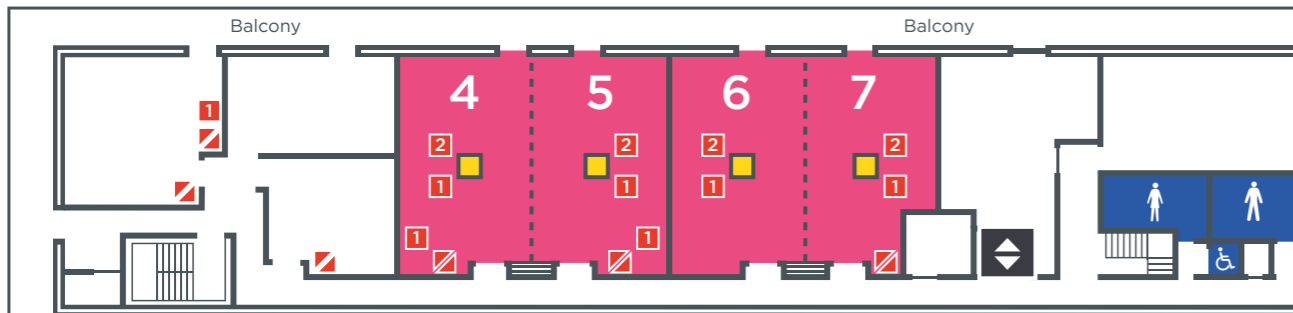

Single room: 18, 19, 20
Double room: 4+5, 6+7, 8+9, 10+11, 12+13, 14+15, 16+17

North Gallery Rooms - capacity chart

	Area	Dimensions	Height	Theatre	*Classroom	*Cabaret	*Banquet	Reception	Boardroom
North Gallery Room 4, 5, 6, 13, 15 or 17	91m ²	12m x 7.6m	3.25m	90	42	48	60	90	34
North Gallery Room 7, 11 or 18	84m ²	12m x 7.6m	3.25m	70	42	40	50	70	34
North Gallery Room 8, 9, 10, 12, 14, 16 or 20	90m ²	12m x 7.5m	3.25m	90	42	48	60	90	34
North Gallery Room 19	274m ²	23.3m x 12.7m	3.25m	248	80	120	160	248	66

Facilities

- Dimmable house lighting
- All suites are acoustically sealed
- All rooms have sun blinds
- Audio visual equipment available on request
- In room temperature control
- Wardrobes available in rooms 11-22
- Natural daylight

Door dimensions

- 1.4m (w) x 2.0m (h)

Maximum loading

- Breakout areas: 5.0kN/m²

Passenger lift dimensions & weight loading

- Lift size: 1.86m (w) x 1.55m (d) x 2.4m (h)
- Door size: 1.1m (w) x 2.09m (h)
- Weight loading: 1,350kg

Key

- 1 Floor box type 1**
2x 13 AMP sockets
4x jack plugs
- 2 Floor box type 2**
2x 13 AMP sockets
1x 15 PIN female PC socket
1x video jack
2x 15 pair audio sockets (L & R)
1x 13 AMP projector plug
- A 3 phase power supply**
available on request.
Location available on technical plans
- Pair fused and switched**
13 AMP sockets

- Ceiling projector mount point**
available on request

- Projection screens**
Location available on technical plans

- Partition wall**

- Toilets**
Male
Female
Accessible (RH/LH – Right/Left hand)

- Public lifts**

- Stairs**

ICC LONDON

EVENT SPACES

Key

- 1 ICC Auditorium (Level 0)
- 2 ICC Capital Hall (Level 0)
- 3 ICC Capital Suite (Level 3)
- 4 ICC Capital Lounge (Level 2)
- 5 ICC London Suite (Level 0)
- 6 Prince Regent Rooms (Level 1)
- 7 Event Halls (Level 1)
- 8 Boulevard (Level 1)
- 9 Boulevard (Level 0)
- 10 ICC Maritime Suite and ICC Maritime Halls (Levels 0 and 3)
- 11 Prince Regent DLR walkway (Level 1)

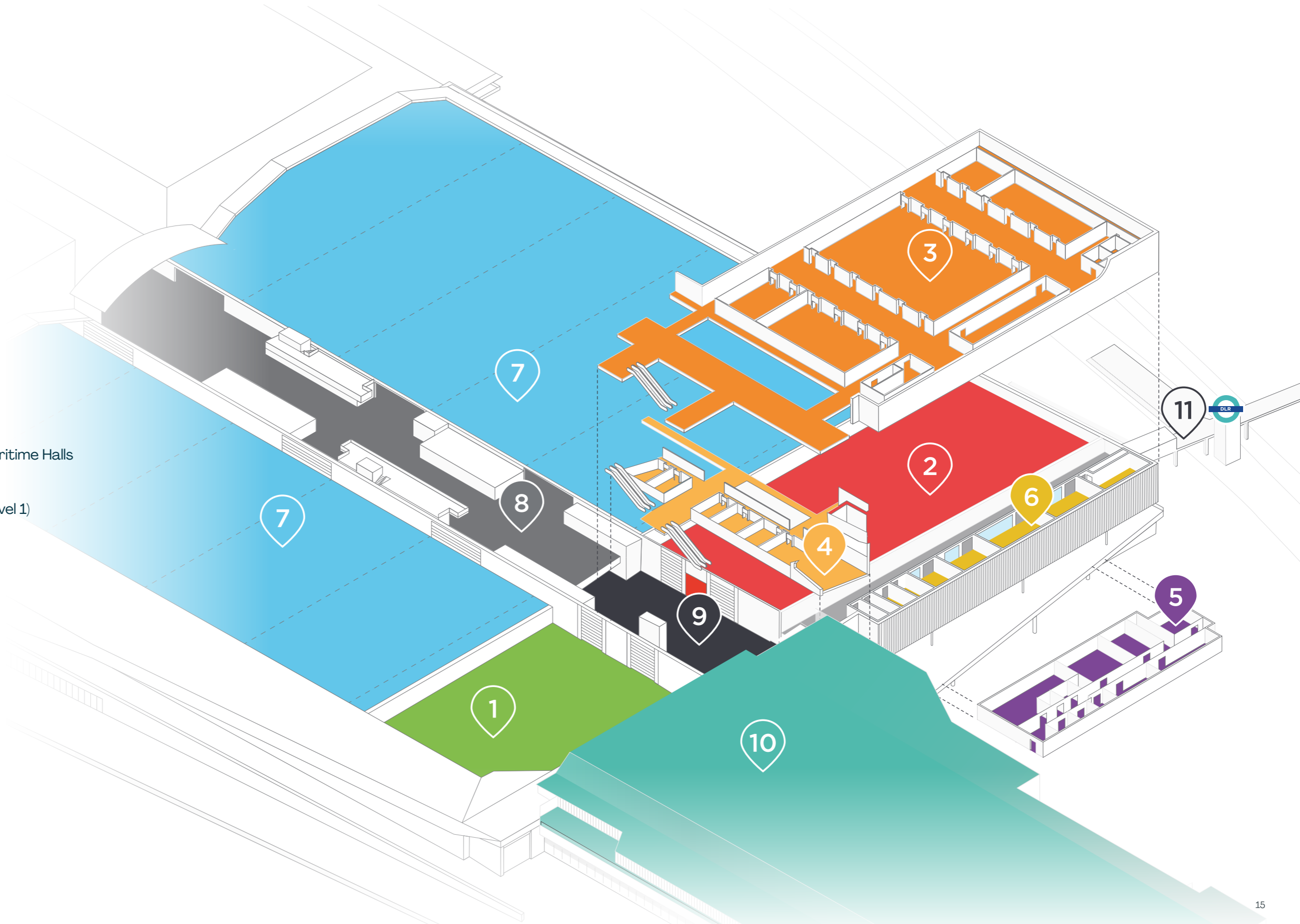

ICC AUDITORIUM

LEVEL 0

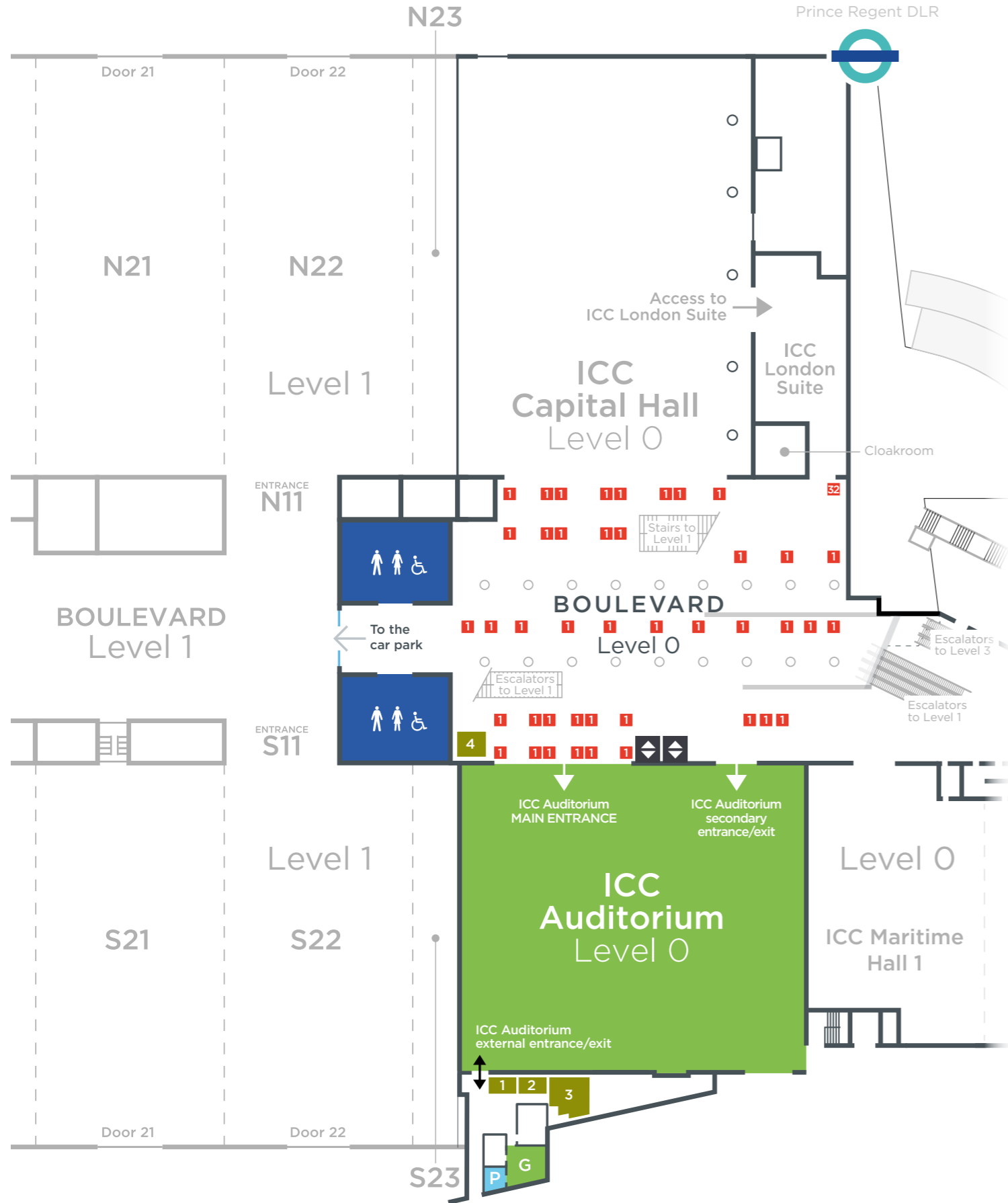

Floor plan examples

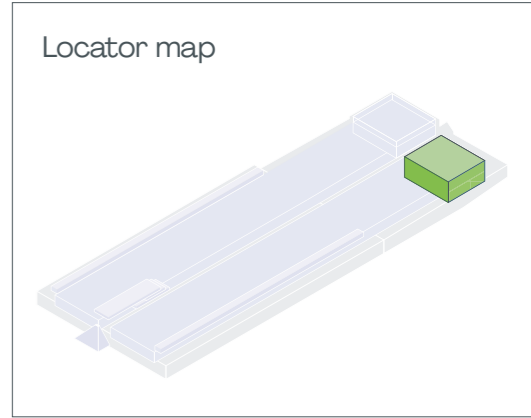

Key features

- Seating for up to 4,200 delegates
- 4,603m² space
- 72.67m (l) x 63.34m (w) x 15.0m (h)
- Acoustic panelling
- 7.2m wide drive-in doorways
- Floor weight loading: 18 kN/m²
- Permanent cabling including IT, electric, water, waste, compressed air
 - Serviced by underfloor ducts every 5.0m North to South and 3.0m East to West
- Auditorium backstage rooms:
 - Green room: 8.7m x 8m, 61.5m² total. Including furniture, plasma screen, service pantry, toilets and shower
 - Organiser office 1: 2.2m x 6.3m, 13.7m² total
 - Organiser office 2: 2.2m x 6.4m, 14m² total
 - Organiser office 3: 8.0m x 8.0m, 64m² total
 - Organiser office 4: 4.0m x 4.7m, 18.8m² total
- AV and stage included (details available on request)
- Easy access to and from ICC Capital Hall
- Boulevard: 1,705m²

Key

- 1** Floor box type 1
2x 13 AMP sockets
4x jack plugs
- 32** 32 AMP single phase supply
- 4** Organiser offices
- P** Pantry
- G** Green room
- Columns
- Toilets**
 - ♂** Male
 - ♀** Female
 - ♿** Accessible
- ↕** Public lifts
- Tiered seating
- Flat floor seating
- }** Drape

ICC CAPITAL HALL

LEVEL 0

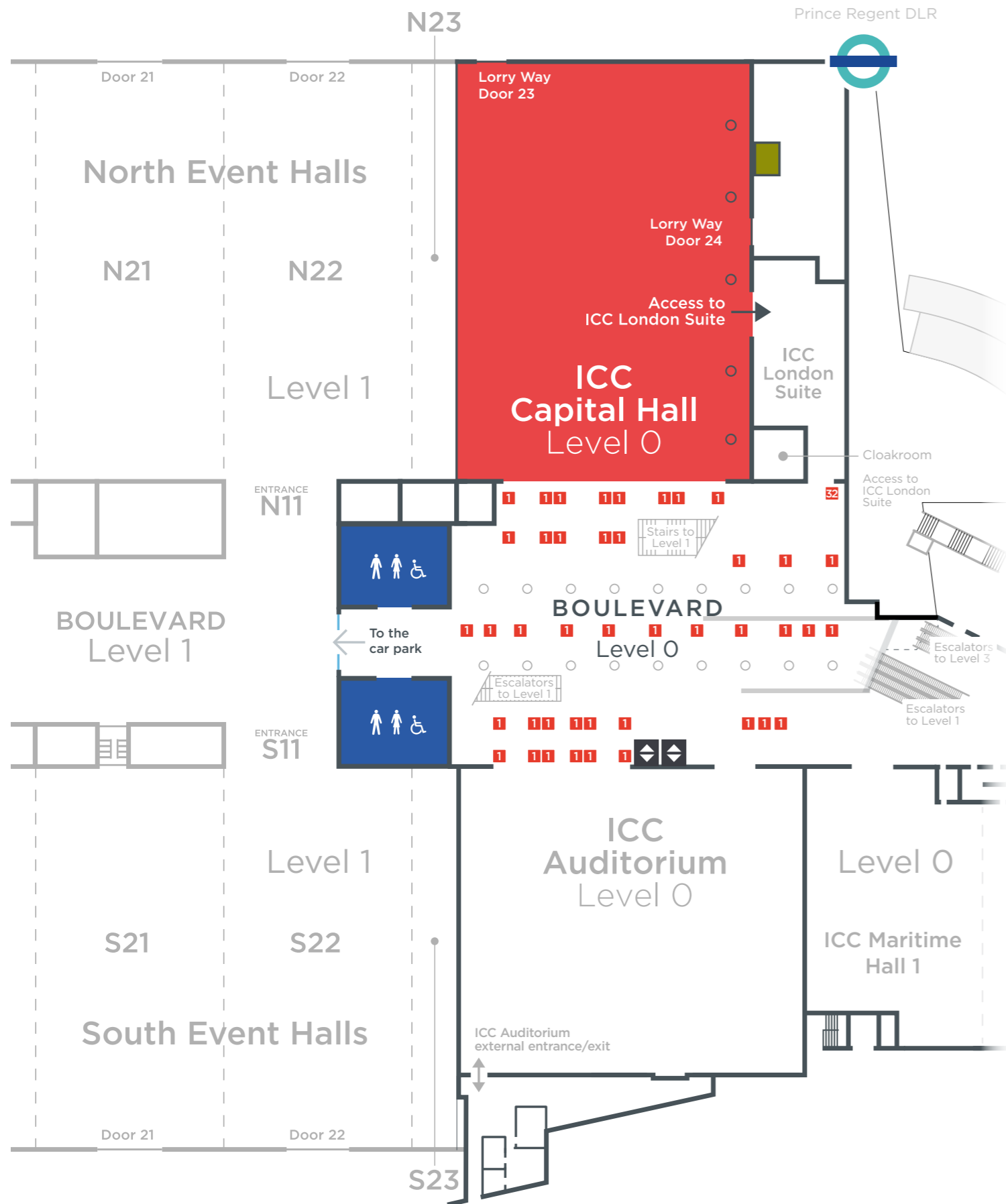

Floor plan examples

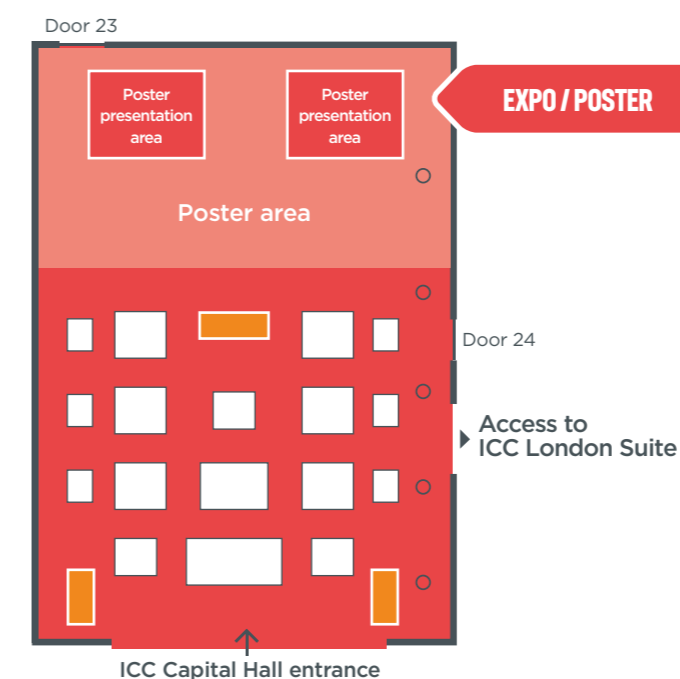
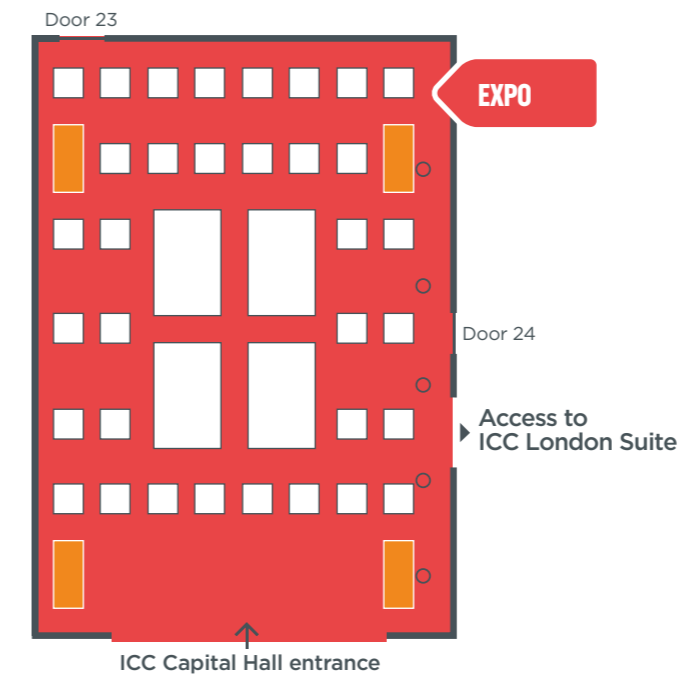
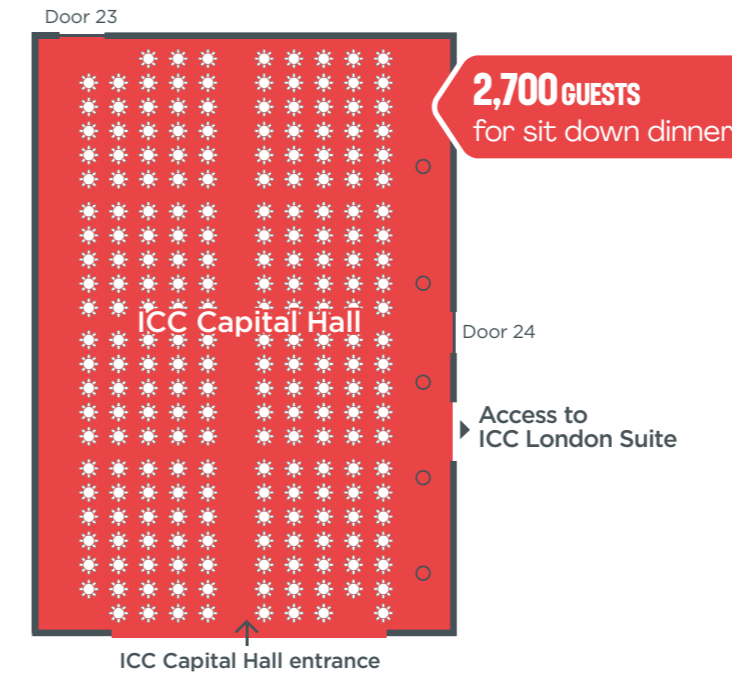

Locator map

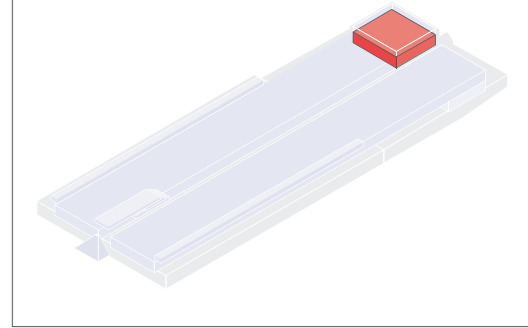

Key features

- Banquet for up to 2,700 guests
- Reception for up to 3,060 guests
- 4,518m² space
- 86.36m (l) x 52.31m (w) x 10.0m (h)
- Lorry Doors (Door 23 and Door 24)
 - Door 24: 8.0m (w) x 5.2m (h)
 - Door 23: 7.2m (w) x 2.8m (h)
- Floor weight loading: 18 kN/m²
- Permanent cabling including IT, electric, water, waste, compressed air - serviced by underfloor duct every 5.0m North to South and 3.0m East to West
- Easy access to and from the ICC Auditorium and direct access into ICC London Suite
- Organiser office
- Boulevard: 1,705m²

Key

- 1** Floor box type 1
2x 13 AMP sockets
4x jack plugs
- 32** 32 AMP single phase supply
- Organiser office**
- Columns**
- Toilets**
 - Male
 - Female
 - Accessible
- Public lifts**

Tables & chairs (using 5ft round tables)*

Exhibition stands*

Catering*

*Please note, tables & chairs, Exhibition stands and Catering layouts are for illustrative purposes only.

ICC CAPITAL SUITE

LEVEL 3

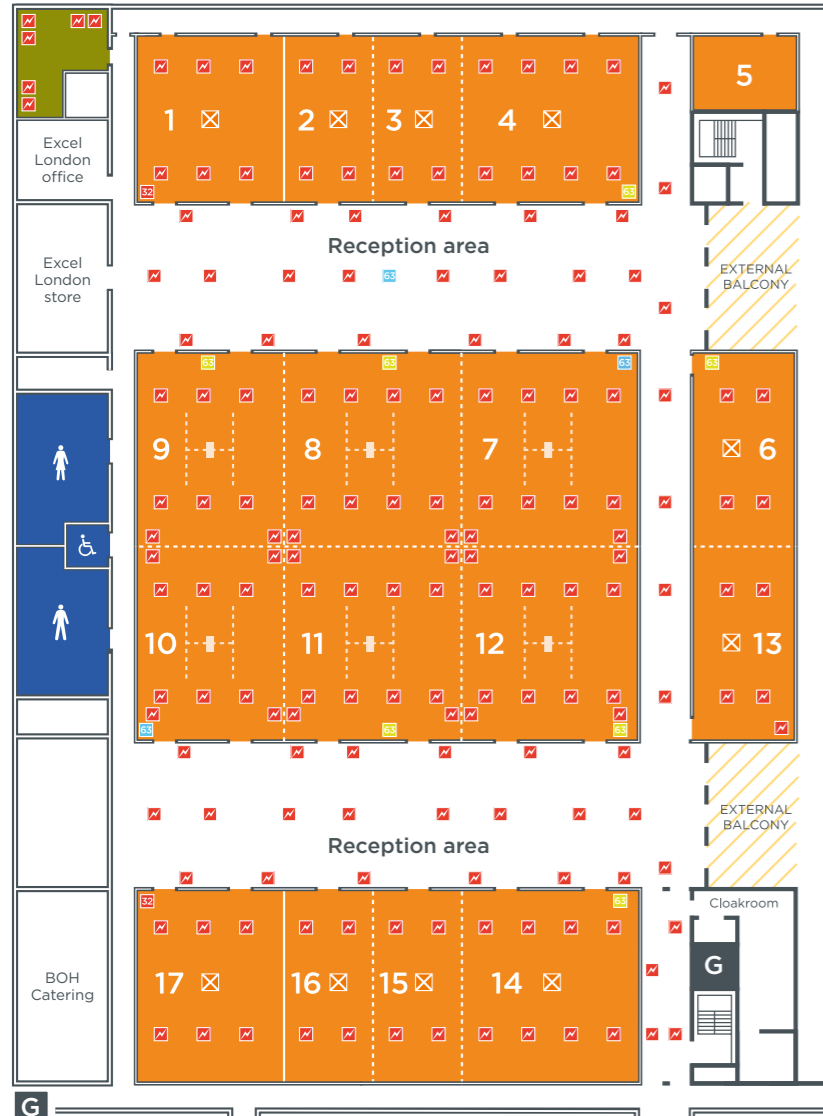

Key

⊗ Individual fixing points to ceiling
50mm dia stainless steel CHS rated at 25kgs with adjacent grommet connection panel.

32 32 AMP single phase supply

63 63 AMP single phase supply

63 63 AMP three phase supply

⊗ Floor box location
with power and data outlets

⊗ Rigging frame
48.3mm dia stainless steel
125kgs per bar, 50kgs per metre with adjacent grommet connection panel

⊗ Partition wall

■ Organiser office

Toilets

- Male
- Female
- Accessible

⬆️ Public lifts

G Goods lifts

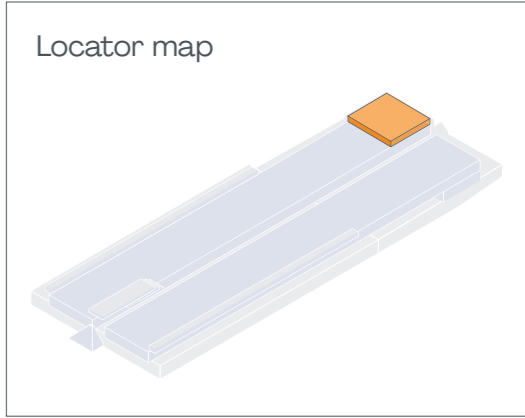

ICC Capital Suite - capacity chart

	Area	Dimensions	Height	Theatre	*Classroom	*Cabaret	*Banquet	Reception	Boardroom	U shape
Room 1	162m ²	12.7m x 12.7m	3.75m	150	75	80	100	150	30	36
Room 2	96m ²	7.5m x 12.7m	3.75m	88	44	48	60	88	20	22
Room 3	96m ²	7.5m x 12.7m	3.75m	88	44	48	60	88	20	22
Room 4	196m ²	15.4m x 12.7m	3.75m	180	90	96	120	180	30	42
Room 5	54m ²	8.9m x 6.1m	3.75m	50	24	n/a	n/a	50	18	n/a
Room 6	135m ²	8.9m x 15.2m	3.75m	124	62	72	80	124	30	30
Room 7	228m ²	15.4m x 14.8m	4.5m	220	105	112	140	210	50	45
Room 8	229m ²	15.5m x 14.8m	4.5m	220	105	112	140	210	50	45
Room 9	190m ²	12.8m x 14.8m	4.5m	180	87	88	110	175	50	39
Room 10	190m ²	12.8m x 14.8m	4.5m	180	87	88	110	175	50	39
Room 11	229m ²	15.5m x 14.8m	4.5m	220	105	112	140	210	50	45
Room 12	228m ²	15.4m x 14.8m	4.5m	220	105	112	140	210	50	45
Room 13	135m ²	8.9m x 15.2m	3.75m	124	62	72	80	124	30	30
Room 14	230m ²	15.5m x 14.8m	3.75m	220	105	112	140	210	30	45
Room 15	113m ²	7.6m x 14.8m	3.75m	60	52	56	60	60	20	36
Room 16	113m ²	7.6m x 14.8m	3.75m	60	52	56	60	60	20	36
Room 17	190m ²	12.8m x 14.8m	3.75m	180	87	88	110	175	30	39
Rooms 2-4	388m ²	30.4m x 12.7m	3.75m	356	178	192	240	356	50	n/a
Rooms 6+13	270m ²	30.4m x 8.9m	3.75m	248	124	144	170	248	60	n/a
Rooms 7-12	1,294m ²	43.7m x 29.6m	4.5m	1,394	594	640	800	1,394	n/a	n/a
Rooms 14-16	456m ²	30.7m x 14.8m	3.75m	418	209	224	280	418	50	n/a

All capacities subject to floorplan approval.

*Classroom numbers are based on three per table (using 6 ft trestle tables); *Cabaret numbers based on a max of eight per table (using 5 ft round tables);

*Banquet numbers based on a max of ten per table (using 5 ft round tables).

Facilities

- Meeting space for up to 2,500 delegates
- Cloakroom
- Outside balconies: 570m² total (285m² each)
- Organisers office: 45m²
- Registration area: 50.7m (l) x 7.8m (w), 420m² total
- Two Reception areas: 46.5m (l) x 11.8m (w), 1,096m² total (548m² each)
- Maximum floor loading: 5.0kN/m²
- 45dB noise resistant partition walls
- Natural daylight in rooms 1, 2, 3, 4, 5, 6 and 13

Door dimensions

- 1.61m (w) x 2.3m (h)
- Distance between meeting room doors - 6m

Goods lift dimensions & weight loading

- Lift size: 1.8m (w) x 2.7m (d) x 2.5m (h)
- Door size: 1.4m (w) x 2.4m (h)
- Weight loading: 2,500kg

AV facilities

- Ability to relay video and sound feeds from one room to up to 15 other rooms at once
- Dimmable and programmable house light system
- Ability to deliver 'cable free' AV setups
- 63AMP or 32AMP power supplies available in each room

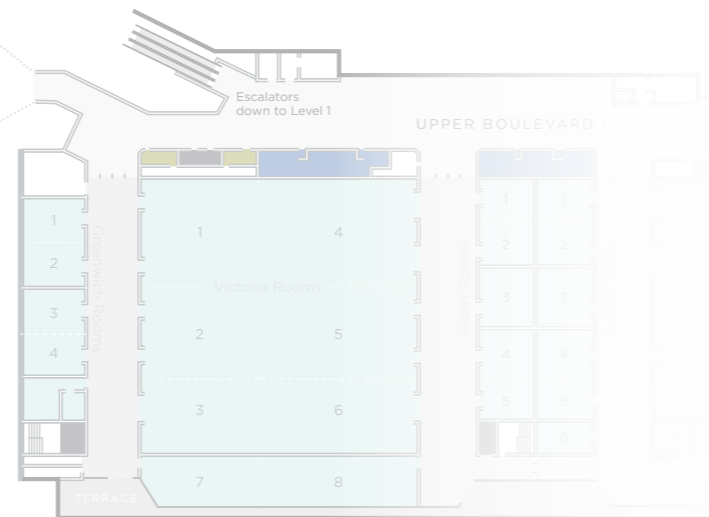

ICC CAPITAL LOUNGE MEETING ROOMS

LEVEL 2

ICC Capital Lounge rooms - Boardroom style

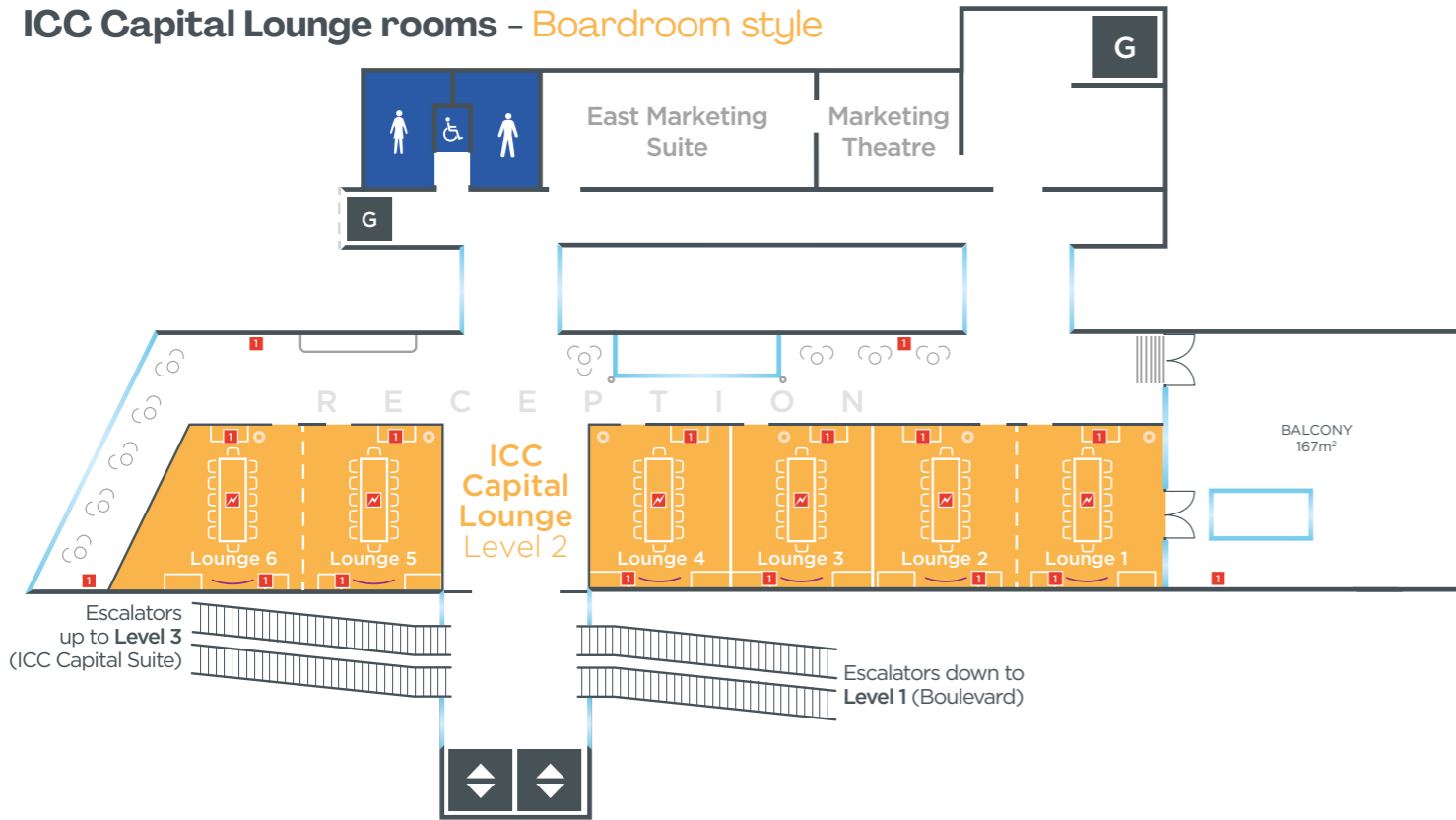

ICC Capital Lounge rooms - Theatre style

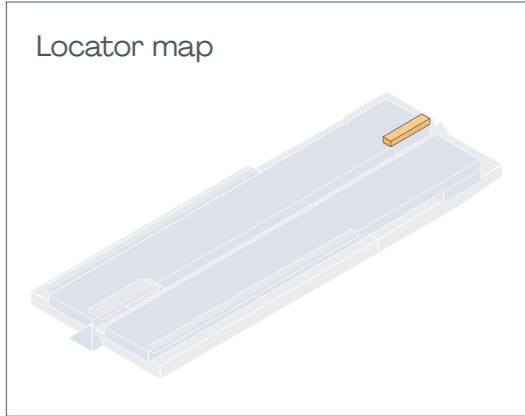
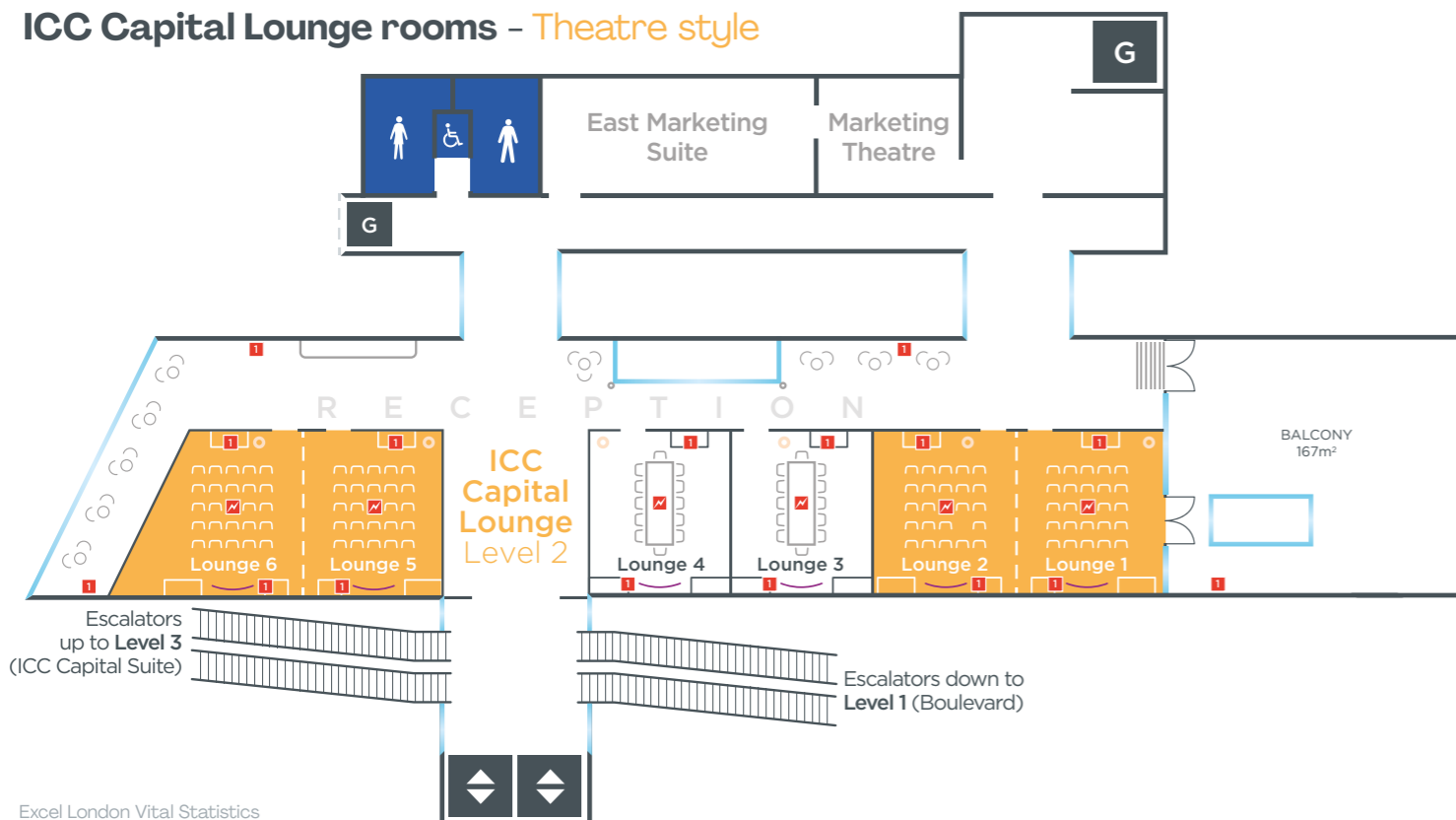

ICC Capital Lounge rooms - capacity chart

	Area	Dimensions	Height	Boardroom	Theatre
Room 1	37m ²	5.7m x 6.5m	2.7m	12	25
Room 2	41m ²	6.3m x 6.5m	2.7m	12	25
Room 3	39m ²	6m x 6.5m	2.7m	12	n/a
Room 4	39m ²	6m x 6.5m	2.7m	12	n/a
Room 5	36m ²	5.6m x 6.5m	2.7m	12	25
Room 6	34m ²	5.2m x 6.5m	2.7m	12	25
Rooms 1+2	78m ²	12m x 6.5m	2.7m	24	50
Rooms 5+6	70m ²	10.8m x 6.5m	2.7m	24	50

All capacities subject to floorplan approval.

Facilities

- Executive style boardroom and chairs
- Intelligent glass providing privacy solutions
- Partition walls (rooms 1 & 2 and 5 & 6)
- Wardrobe in each room
- 45dB noise partition wall (rooms 1 & 2 and 5 & 6)
- Digital signage outside each room
- Digital screen at main entrance doors
- In room temperature control

Reception

- Capacity of 300 including reception area
- Breakout area with a hospitality unit
- 13AMP power points

AV Inclusions

- 65" LED curved screens
- Built-in sound system
- Ability to stream content to two screens simultaneously (rooms 1 & 2 or 5 & 6 combined)

Key

- 1 13 AMP power points
- 2 13 AMP supply floor boxes
- 3 Partition wall
- 4 65" LED curved screen
- 5 Reception area seating
- 6 Column
- Toilets**
- ♂ Male
- ♀ Female
- ♿ Accessible
- ↕ Public lifts
- G Goods lifts

ICC LONDON SUITE

LEVEL 0

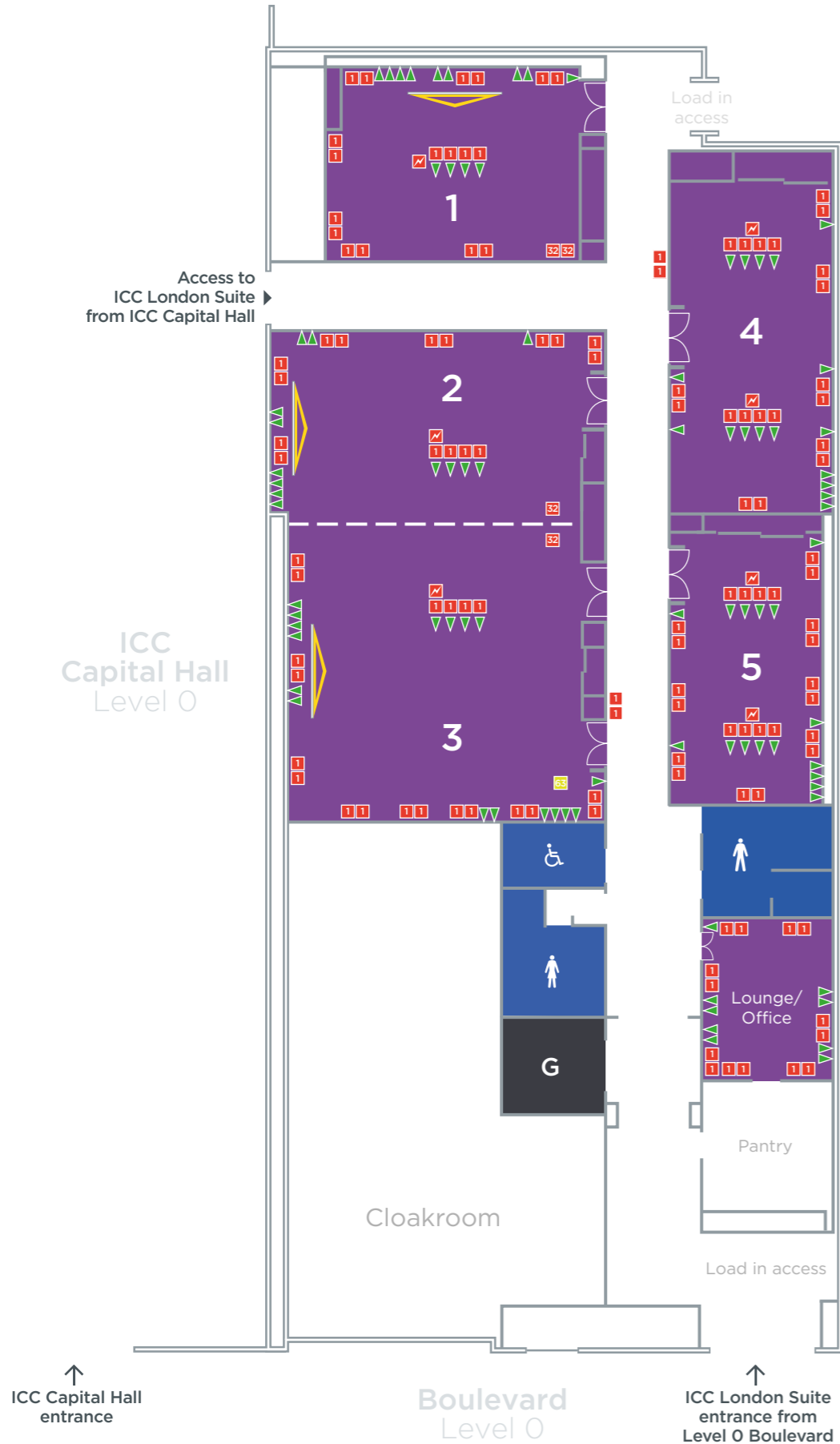
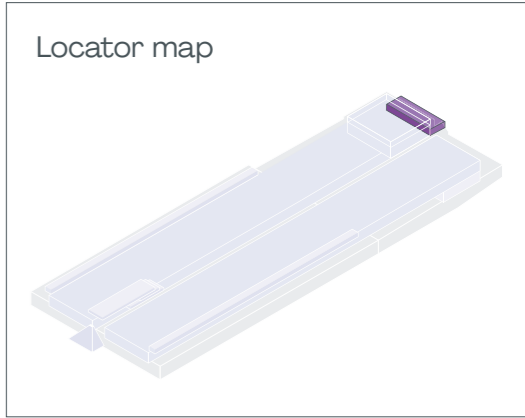

ICC London Suite - capacity chart

	Area	Dimensions	Height	Theatre	*Classroom	*Cabaret	*Banquet	Reception	Boardroom	U shape
Room 1	55m ²	8.4m x 6.4m	3.3m	56	18	32	40	56	20	16
Room 2	71m ²	10.4m x 6.4m	3.3m	60	24	32	40	60	24	20
Room 3	102m ²	9.9m x 9.9m	3.3m	112	40	48	60	112	32	24
Room 4	60m ²	11.1m x 5.3m	2.8m	60	24	24	30	60	22	n/a
Room 5	50m ²	9m x 5.1m	2.8m	50	16	16	20	50	20	n/a
Lounge/Office	20m ²	4m x 5m	2.8m	n/a	n/a	n/a	n/a	n/a	n/a	n/a
Rooms 2+3	173m ²	16.4m x 9.9m	3.3m	200	72	80	100	200	n/a	38

All capacities subject to floorplan approval.

*Classroom numbers are based on three per table (using 6 ft trestle tables); *Cabaret numbers based on a max of eight per table (using 5 ft round tables);

*Banquet numbers based on a max of ten per table (using 5 ft round tables).

Facilities

- 5 individual meeting rooms for up to 200 delegates
- In room temperature control
- 45dB noise resistant partition wall (rooms 2 and 3)

Door dimensions

- 1.65m (w) x 2.04m (h)

Goods lift dimensions & weight loading

- Lift size: 1.8m (w) x 2.7m (d) x 2.5m (h)
- Door size: 1.4m (w) x 2.4m (h)
- Weight loading: 2,500kg

AV inclusions

- Rooms 4 to 5 and lounge:
- 47" LED screen

Key

- 1 13 AMP supply
- 32 32 AMP single phase supply
- 63 63 AMP single phase supply
- ⚡ Floor box location
with power and data outlets
- ▬ Partition wall
- ▶ Projection screens
- ▶ Data point
- Toilets**
- ♂ Male
- ♀ Female
- ♿ Accessible
- G Goods lift

PRINCE REGENT ROOMS

LEVEL 1

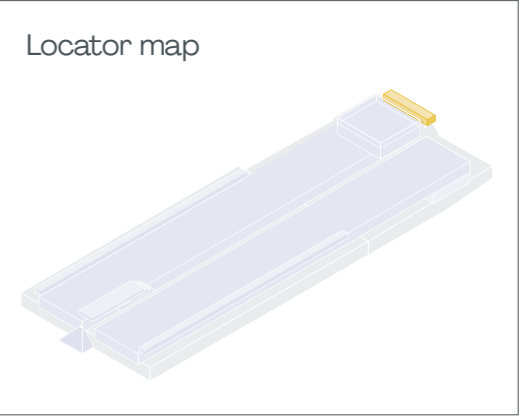
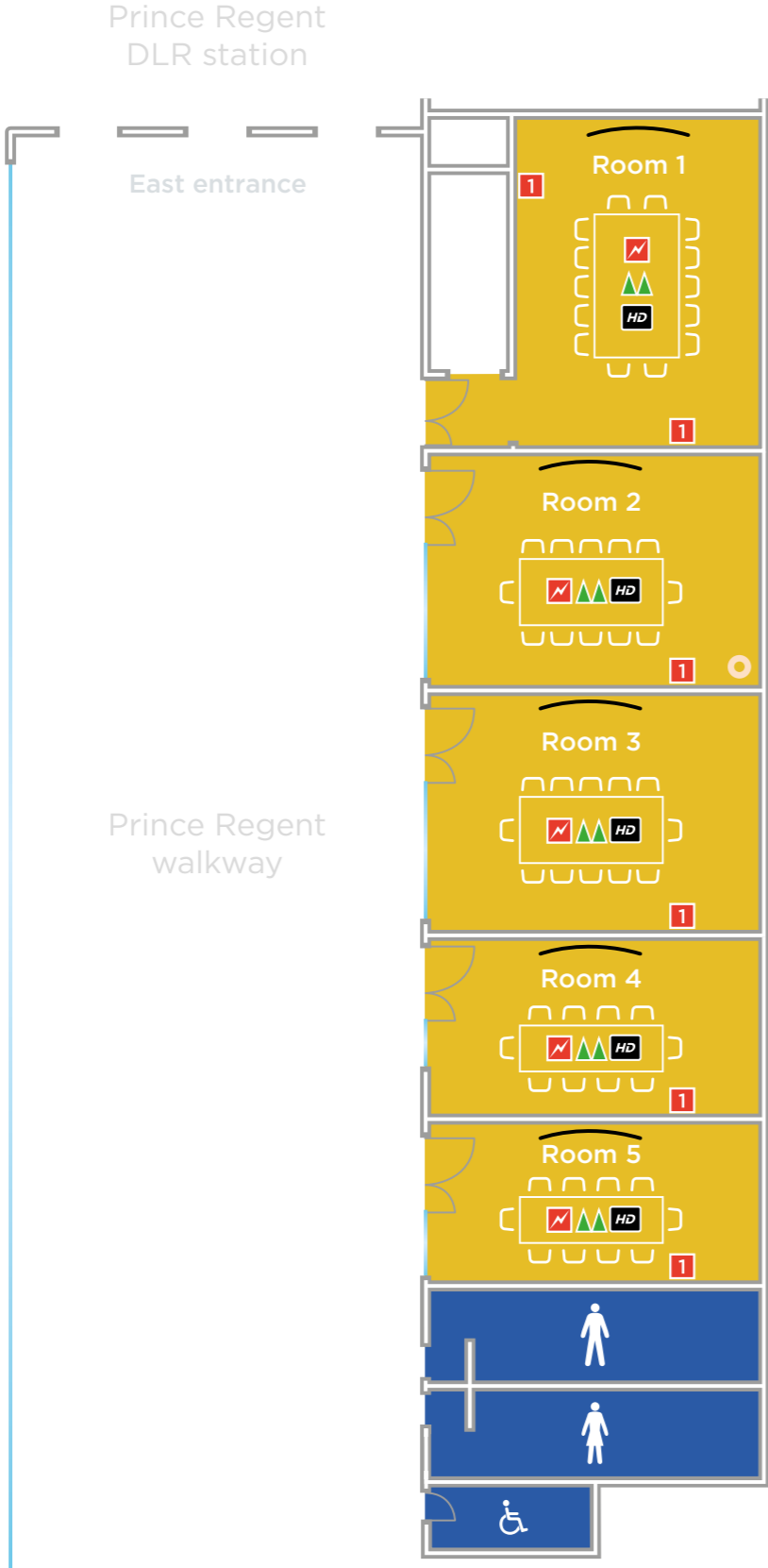

Prince Regent Rooms - capacity chart

	Area	Dimensions	Height	*Boardroom
Room 1	32m ²	4.8m x 6.5m	2.8m	14
Room 2	31m ²	6.6m x 4.7m	2.8m	12
Room 3	31m ²	6.6m x 4.7m	2.8m	12
Room 4	22m ²	6.6m x 3.4m	2.8m	10
Room 5	22m ²	6.6m x 3.4m	2.8m	10

*Boardrooms cannot be removed.

Facilities

- Executive style boardroom set up
- AV facilities
- Natural daylight (rooms 1 to 4)
- In room temperature control

AV inclusions

- Room 1: 75" LED screen
- Rooms 2 to 5: 55" LED screen
- IT connections to link laptop to screen

Key

- 1** 13 AMP power points
- ⚡** 13 AMP supply floor boxes
- Column
- HD** HDMI outlet
- ▶** Data point
- Digital screen
- Toilets**
 - ♂** Male
 - ♀** Female
 - ♿** Accessible

ICC MARITIME HALLS & SUITE

EVENT SPACES

Key

- 1 ICC Maritime Halls 1-6 (Level 0)
- 2 Lower Boulevard (Level 0)
- 3 ICC Maritime Lounge (Level 2)
- 4 ICC Maritime Suite (Level 3)
- 5 Upper Boulevard (Level 3)
- 6 Prince Regent DLR (Level 1)

Level 3

Level 0

Level 2

ROYAL VICTORIA DOCK

EVENT SQUARE

DLR

ICC MARITIME SUITE LEVEL 3



Prince Regent DLR
for Excel ICC

Facilities

- Overall capacity for 7,000 people
- 37 individual meeting rooms
- Maritime Lounge (Level 2): 90m²
- Three external south-facing terraces
- Four organiser offices (20m² each)
- Large reception areas
- Upper boulevard: 1,938m² (400m long)
- Natural daylight in Thames Rooms, Connaught Rooms & Victoria Rooms 7/8
- Easy access to and from ICC Capital Suite
- Maximum floor loading = 5.0 kN/m²
- 52-62dB noise resistant partition walls
- Dimmable and programmable house light system
- 63AMP, 32AMP or 16AMP power supplies available in each room

AV Inclusions (Thames Rooms and Maritime Lounge)

- 85" Plasma Screen with integrated video calling and HDMI cabling to boardroom table

Door dimensions

- 2.1m (w) x 2.1m / 3.0m (h)

Goods lift dimensions & weight loading

- Lifts GL01/03 size: 3.5m (w) x 5.0m (d) x 2.5m (h)
(Weight loading: 5,000kg)
- Lifts GL02/04 size: 2.0m (w) x 2.5m (d) x 2.5m (h)
(Weight loading: 2,500kg)

Key

Event Rooms

Upper Boulevard

Organiser offices

Build area
includes wall mounted power sockets at regular intervals

Toilets

- Male
- Female
- Accessible & baby change

Stairs

Public lifts

Goods lifts
GL01 GL02
GL03 GL04

Foyer

Floor box location
with power and data outlets



ICC Maritime Suite - capacity chart

	Area	Dimensions	Height	Theatre	Classroom*	Cabaret*	Banquet*	Reception	Boardroom	U-shape
Greenwich Room 1	87m ²	9.8m x 8.8m	4.5m	78	18	32	32	105	20	18
Greenwich Room 2	92m ²	10.4m x 8.8m	4.5m	78	18	32	32	105	20	18
Greenwich Room 3	93m ²	10.4m x 8.8m	4.5m	78	18	32	32	105	20	18
Greenwich Room 4	87m ²	10.4m x 8.3m	4.5m	72	18	24	24	105	20	18
Victoria Room 1	484m ²	22.5m x 21.5m	6m	455	144	216	216	455	68	54
Victoria Room 2	405m ²	22.5m x 18m	6m	370	126	168	184	370	64	52
Victoria Room 3	316m ²	22.5m x 14m	6m	305	90	120	120	305	56	48
Victoria Room 4	647m ²	30.1m x 21.5m	6m	600	208	288	296	600	84	70
Victoria Room 5	542m ²	30.1m x 18m	6m	495	182	224	240	495	80	68
Victoria Room 6	422m ²	30.1m x 14m	6m	410	130	160	168	410	72	64
Victoria Room 7	238m ²	23.6m x 10.6m	4.5m	210	70	88	80	210	48	44
Victoria Room 8	315m ²	31.4m x 10.6m	4.5m	300	110	128	112	300	68	64
Victoria Rooms 1-6	2,815m ²	52.6m x 53.4m	6m	2,635	924	1,200	1,296	2,635	176	132
Victoria Rooms 7-8	553m ²	55m x 10.2m	4.5m	510	198	243	208	510	108	100
Albert Room 1	87m ²	10.3m x 8.4m	4.5m	66	18	24	24	85	20	18
Albert Room 2	90m ²	10.3m x 8.7m	4.5m	78	18	24	32	85	20	18
Albert Room 3	124m ²	10.3m x 12m	4.5m	117	30	40	40	120	28	22
Albert Room 4	101m ²	10.3m x 9.7m	4.5m	78	24	32	32	100	24	20
Albert Room 5	82m ²	10.3m x 7.9m	4.5m	66	18	24	24	80	20	18
Trinity Room 1	86m ²	10.2m x 8.4m	4.5m	66	18	24	24	85	20	18
Trinity Room 2	89m ²	10.2m x 8.7m	4.5m	78	18	24	32	85	20	18
Trinity Room 3	123m ²	10.2m x 12m	4.5m	117	30	40	40	120	28	22
Trinity Room 4	100m ²	10.2m x 9.7m	4.5m	78	24	32	32	100	24	20
Trinity Room 5	82m ²	10.2m x 7.9m	4.5m	66	18	24	24	80	20	18
Trinity Room 6	65m ²	10m x 6.4m	4.5m	48	12	16	16	59	16	16
George V Room 1	666m ²	30.3m x 21.5m	6m	610	208	288	288	610	84	70
George V Room 2	789m ²	30.3m x 26m	6m	735	260	384	336	735	96	76
George V Room 3	666m ²	30.3m x 21.5m	6m	615	208	288	288	615	84	70
George V Room 4	789m ²	30.3m x 26m	6m	735	260	384	336	735	96	76
George V Rooms 1-4	2,909m ²	60.6m x 47.5m	6m	2,695	1,040	1,512	1,456	2,695	188	136
Thames Room 1	48m ²	7.2m x 6.6m	3m	n/a	n/a	n/a	n/a	n/a	16*	n/a
Thames Room 2	50m ²	7.6m x 6.6m	3m	n/a	n/a	n/a	n/a	n/a	16*	n/a
Thames Room 3	45m ²	7.3m x 5.8m	3m	n/a	n/a	n/a	n/a	n/a	16*	n/a
Thames Room 4	49m ²	7.3m x 6.6m	3m	n/a	n/a	n/a	n/a	n/a	16*	n/a
Thames Room 5	50m ²	7.6m x 6.6m	3m	n/a	n/a	n/a	n/a	n/a	16*	n/a
Thames Room 6	52m ²	7.8m x 6.6m	3m	n/a	n/a	n/a	n/a	n/a	16*	n/a
Connaught Room 1	223m ²	17.9m x 12.4m	4.5m	210	60	96	96	210	44	34
Connaught Room 2	164m ²	17.9m x 9.1m	4.5m	160	36	64	64	160	36	30
Connaught Room 3	164m ²	17.9m x 9.1m	4.5m	160	36	64	64	160	36	30
Connaught Room 4	169m ²	17.9m x 9.4m	4.5m	160	36	64	64	160	40	32
Connaught Rooms 1-4	720m ²	17.9m x 40m	4.5m	690	204	304	304	690	92	58

All capacities subject to floorplan approval.

*Classroom numbers are based on 2 per table (using 6ft trestle tables)

*Cabaret & Banquet numbers based on a max of eight per table (using 5ft round tables)

*Thames Rooms are fixed boardrooms for 16 (the furniture cannot be moved/removed)

ICC MARITIME HALLS

LEVEL 0

ICC Maritime Halls

	Area	Dimensions	Height
Hall 1	1,672m ²	31.1m x 53.8m	9.6m
Hall 2	1,693m ²	31.1m x 53.8m	9.6m
Hall 3	2,044m ²	38.7m x 53.8m	9.6m
Hall 4	2,118m ²	38.9m x 53.8m	9.6m
Hall 5	2,054m ²	38.8m x 53.8m	9.6m
Hall 6	1,940m ²	37.4m x 53.8m	9.6m
All halls	11,521m ²	216m x 53.8m	9.6m

Facilities

- 11,521m² of column free event space
- Partitioned floor space with moveable walls (3 available)
- Easy visitor access from 2,600m² (200m long) boulevard (Level 0)
- Private lorryway accessing event halls with 7.5m (w) by 5.5m (h) drive-in doorways
- Event Hall floor weight loading = 20 kN/m²
- 46dB noise resistant partition walls
- Permanent cabling including IT, electric and water (waste available in certain locations)
 - Serviced by underfloor ducts
- Four organiser offices: 12m² - 20m²
- Direct access to ICC Auditorium and ICC Capital Hall
- Direct access to Event Square (external space) from boulevard
- Direct load in access to GL03 via ICC Maritime Hall 5 or lorryway

Goods lift dimensions & weight loading

- Lifts GL01/03 size: 3.5m (w) x 5.0m (d) x 2.5m (h)
(Weight loading: 5,000kg)
- Lifts GL02/04 size: 2.0m (w) x 2.5m (d) x 2.5m (h)
(Weight loading: 2,500kg)

Key

- ICC Maritime Halls
- Lower Boulevard
- Organiser offices
- Toilets
- Catering Back of House
- Stairs
- Public lifts
- Goods lifts

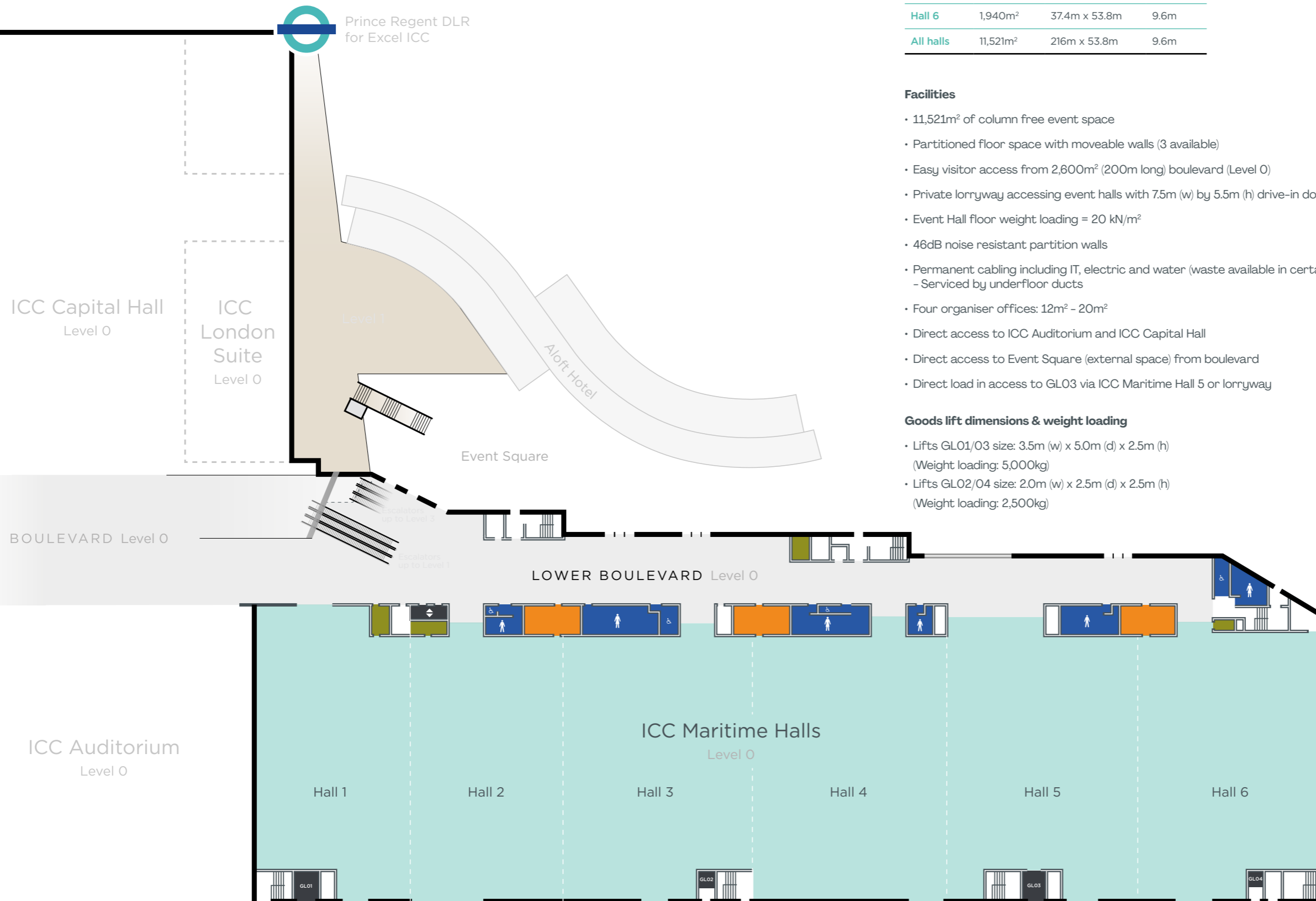



Excel London Management Office

Warehouse K
One Western Gateway
London E16 1XL

Telephone + 44 (0)20 7069 4602

Sales Enquiries – Conferences & Events and Exhibitions

SalesEnquiries@excel.london

www.excel.london

ADNEC
مجموعة أدنيك **GROUP**

About ADNEC Group

ADNEC Group is an international venue development and business management company; a wholly owned subsidiary of Modon Holding P.S.C.

ADNEC Group's portfolio includes the Abu Dhabi National Exhibition Centre, Excel London, Al Ain Convention Centre and the Business Design Centre, as well as various global hotel projects. With a commitment to top-tier venue facilities and client relationships, the company aims to be the world's leading provider for exhibitions, conferences, and live events. Its Executive Office is located in Abu Dhabi, the capital city of the United Arab Emirates.

www.adnecgroup.ae